



Push Buttons

Series CZ0212



Prodcuts Features

- The rated current of explosion-proof switches for panel mounting is up to 16A and the mechanical life is 1,000,000 times. There are silver or gold-platead silver contact points for options.
- Explosion-proof signal lamps for panel mounting have high brightness, long life. The electric life is more than 100,000 hours.
- Degree of protection IP66.
- IECEx International Certification, ATEX European Approval.

Product Parameter

Product type:	CZ0212 Explosion-proof signal lamp with push button for panel mounting		
Certification:	CCC IECEX ATEX		
Application range (zones):	2G/Gb/zone 1; 2D/Db/zone 21		
Min.ambient temperature:	-40°C	Light source:	LED
Max.ambient temperature:	+50°C	Power consumption:	Pmax≤1W
Degree of protection:	IP66(Match operation head)	Cable entry outer diameter:	Φ5.5 ~ 13mm
Terminals:	2×2.5mm ²		
Button Rated voltage/Rated current:	AC250V/10A	DC24V/1A	
Rated voltage of signal lamp:	12-28V AC/DC 20-250V AC/DC		





فرست اتوماشن

Push Buttons

Series CZ0212

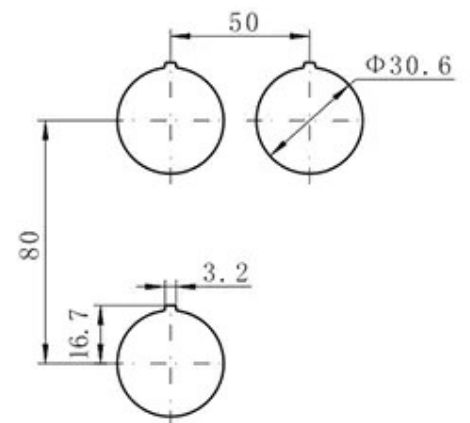
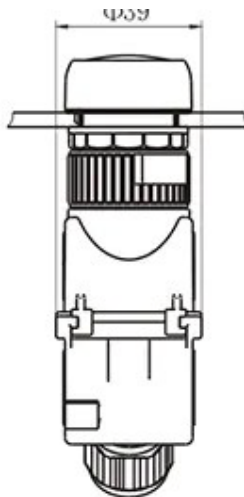
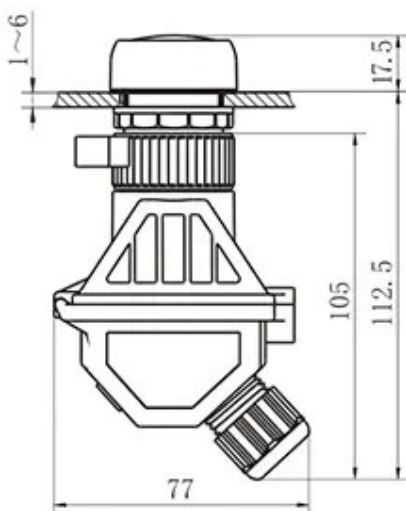

Mounting pitches





فرست اوتوماشن

Push Buttons

Series CZ0212



Illustration	Order No.	
	Voltage of signal lamp	
	12V - 28V AC/DC	20V - 250V AC/DC
 CZ0212	CZ0212-9303-PR	CZ0212-9301-PR
	CZ0212-9303-PG	CZ0212-9301-PG
	CZ0212-9303-PY	CZ0212-9301-PY
	CZ0212-9303-PB	CZ0212-9301-PB
	CZ0212-9303-PW	CZ0212-9301-PW
	CZ0212-9403-PR	CZ0212-9401-PR
	CZ0212-9403-PG	CZ0212-9401-PG
	CZ0212-9403-PY	CZ0212-9401-PY
	CZ0212-9403-PB	CZ0212-9401-PB
	CZ0212-9403-PW	CZ0212-9401-PW







فرست اوتوماشن

Push Buttons

Series CZ0212



Accessories

	<p>For label of $\Phi 39$mm, laser markings in 1-2 lines CZ4000-4031/1</p>
	<p>For label of $\Phi 39$mm, laser markings in 2-3 lines CZ4000-4031/6</p>
	<p>For label of $\Phi 39$mm, laser markings in 1-2 lines CZ4000-4031/4</p>
	<p>Yellow labels for E-stop pushbuttons are used for operation heads of $\Phi 40$mm CZ4000-4032/0</p>







فرست اتوماشن

Push Buttons

Series CZ0212



Accessories

	<p>Yellow labels for E-stop pushbuttons are used for operation heads of $\Phi 40\text{mm}/\Phi 55\text{mm}$ CZ4000-4003/10</p>
	<p>Spanners are used to tighten plastic nuts M30x1.5 4000-4006</p>
	<p>Brass padlock B1730</p>
	<p>Spare key is general-purpose Y001-G01</p>
	<p>Flexible cable $2 \times 0.75\text{mm}^2$ $3 \times 0.75\text{mm}^2$ $4 \times 0.75\text{mm}^2$ $2 \times 1.5\text{mm}^2$ $4 \times 1.5\text{mm}^2$</p> <p>Flexible cable, length 3m RVV $2 \times 0.75/3$ RVV $3 \times 0.75/3$ RVV $4 \times 0.75/3$ RVV $2 \times 1.5/3$ RVV $4 \times 1.5/3$</p>