



فرست اوتوماشن

Light Fittings

Series CZ0870n



Products Features

- Good electromagnetic compatibility and it does not cause any interference to the system power grid.
- Good performance of vibration due to the LED is the solid-state light source.
- It is convenient to be mounted and maintained.
- Degree of protection is up to IP66.
- IECEx and ATEX certified

Product Parameter

| | |
|-----------------------------------|------------------------------------|
| Product type: | LED Explosion-proof light fittings |
| Certification: | CCC IECEx ATEX |
| Application range (zones): | 3G/Gc/zone 2; 2D/Db/zone 21 |
| Min.ambient temperature: | -40°C |
| Max.ambient temperature: | +55°C |
| Degree of protection: | IP66 |
| Rated voltage: | 100 ~ 240V AC 50/60Hz |



فرست اوتوماشن

Light Fittings

Series CZ0870n



Contact

info@first-automation.com.eg/ • 01101619222 – 01100200886 • <https://first-automation.com.eg/>



فرست اوتوماشن

Light Fittings

Series CZ0870n

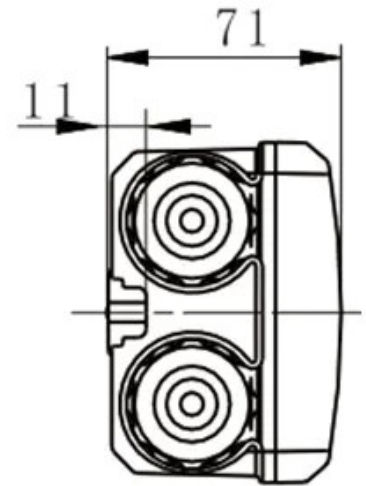
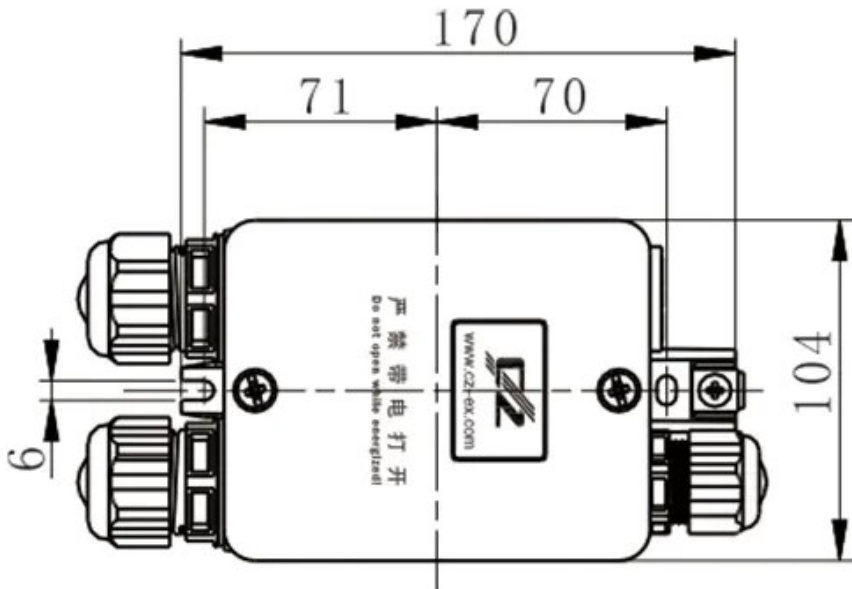



فرست اوتوماشن

Light Fittings

Series CZ0870n

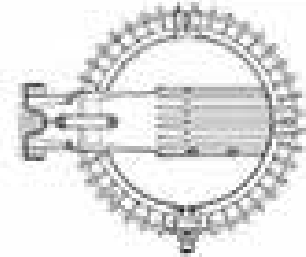
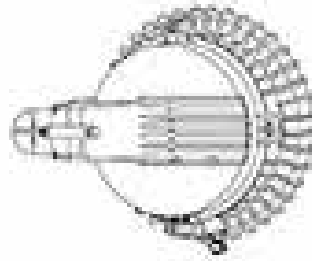
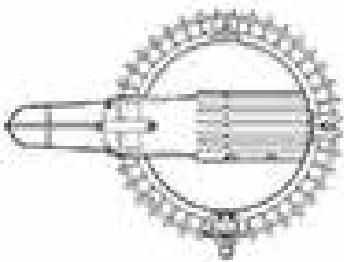
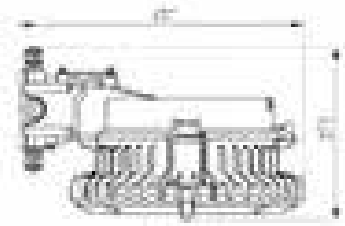
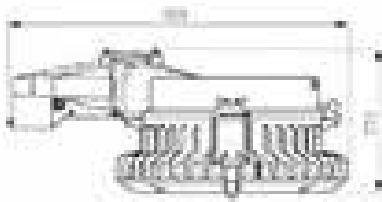

A represents a built-in mounted fixture. M20 cable gland.

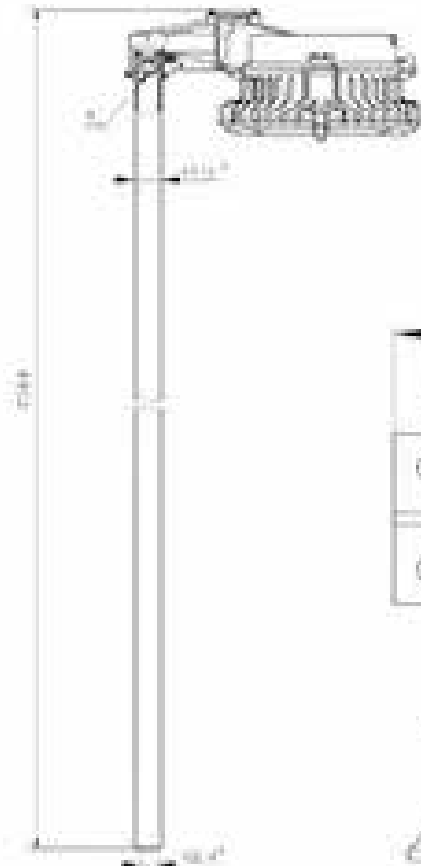

C --- Lamp cup mounted in the angle of 90° Torax type

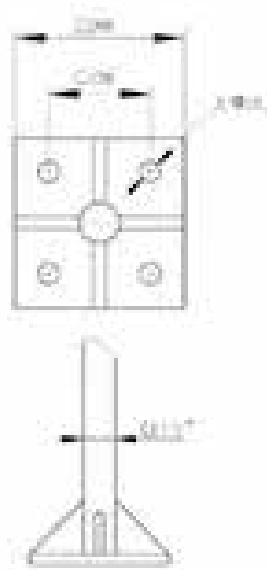

Flange type

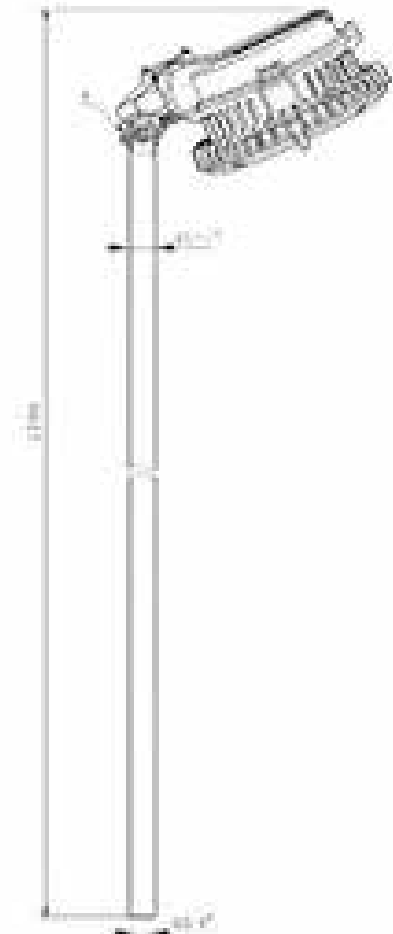

D --- Lamp cup mounted in the angle of 25° Torax type



فرست اوتوماشن

Light Fittings

Series CZ0870n

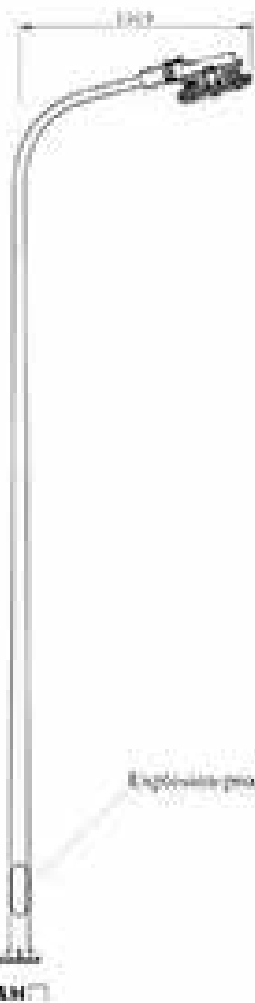
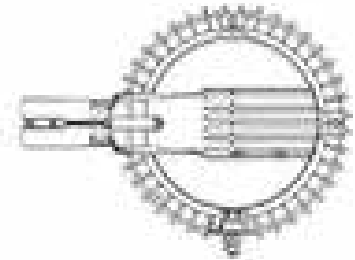
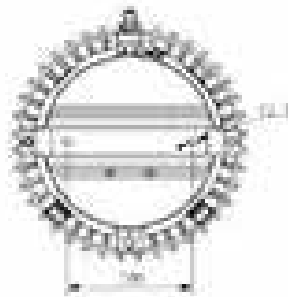
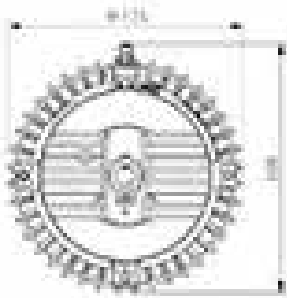
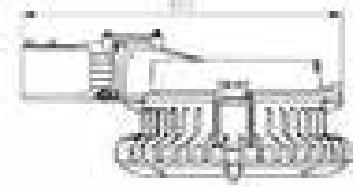
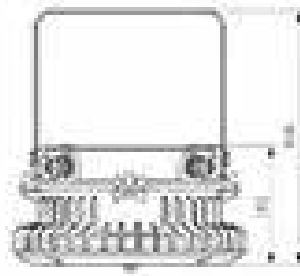
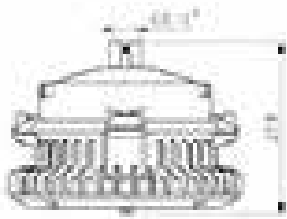

Explosion-proof terminal box

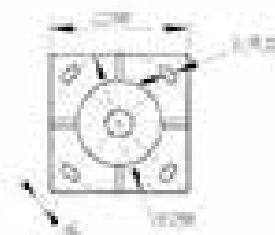

Contact

info@first-automation.com.eg/ • 01101619222 – 01100200886 • https://first-automation.com.eg/



فرست اوتوماشن

Light Fittings

Series CZ0870n



Illustration

Order No.



CZ0870n/105□-LED90W-B+□



CZ0870n/105□-LED120W-B+□



CZ0870n/105□-LED160W-B+□



CZ0870n/108□-LED90W-B+□



CZ0870n/108□-LED120W-B+□



CZ0870n/108□-LED160W-B+□



CZ0870n/110□-LED90W-B+□



CZ0870n/110□-LED120W-B+□



CZ0870n/110□-LED160W-B+□



CZ0870n/112□-LED90W-B+□



CZ0870n/112□-LED120W-B+□



CZ0870n/112□-LED160W-B+□

Contact

info@first-automation.com.eg/ • 01101619222 – 01100200886 • <https://first-automation.com.eg/>



فرست اوتوماشن

Light Fittings

Series CZ0870n



Optional Ex components



| CZ0220 Series Plastic stopping plugs, the reducer



| CZ0221 Metal cable glands



| CZ0220 Series Plastic cable glands, stopping plugs



| CZ0226 Increased safety cable glands



| CZ0527, CZ1725/27 Increased safety breathing, drainage valve



| CZ0227 Increased safety metal cable glands



| CZ1725/1C Metal cable glands



| CZ1725/2A Metal cable glands



| CZ1725/3A Metal stopping plug



| CZ1725/1A Metal cable glands



| CZ1725/4A The reducer



| CZ1725/1B Metal cable glands



فرست اوتوماشن

Light Fittings

Series CZ0870n



Accessories



D0879/2

Mounting bracket
Accessories for bracket type lamp



D8726

Accessories for platform type lamp, G1 1/2 "
galvanized steel
pipe material and powder coated surface



فرست اوتوماشن

Light Fittings

Series CZ0870n



Accessories



D8725

Lamp pole of fence type
Accessories for platform type lamp, G1 1/2 "
galvanized steel
pipe material and powder coated surface

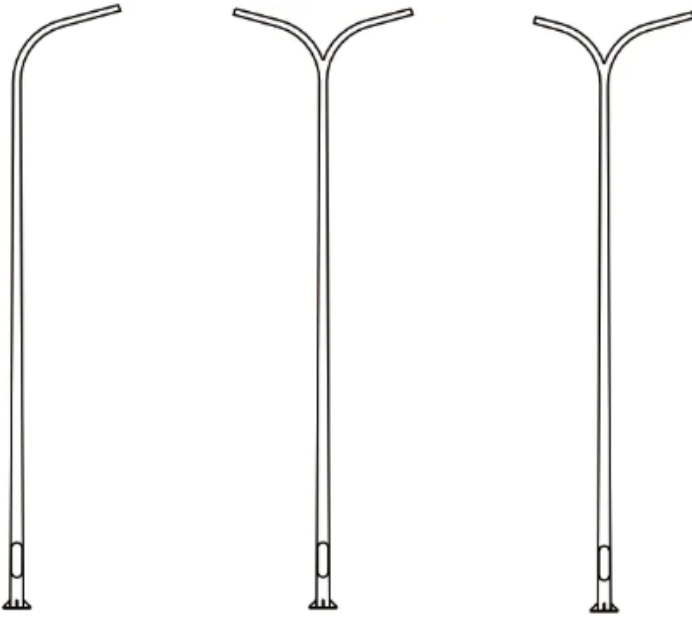

AH,BH,CH

AH:Lamp pole of single arm
BH:Lamp pole of double arms with equal length
CH:Lamp pole of double arms with non-equal
length



فرست اوتوماشن

Light Fittings

Series CZ0870n



Accessories



CZ0930

Code: 10,11

Single lamp equipped
with one fuse

code: 20,21

Double lamps equipped
with two fuses



D732

G3/4"-300

Straight pipe

Accessories for bracket type, galvanized steel pipe
material
and powder coated surface



فرست اوتوماشن

Light Fittings

Series CZ0870n



Accessories



D8722/3

Ceiling bracket



D623

500mm

Chain type accessories

Accessories for bracket type lamp, M8 bolt, made
from steel
with zinc-coated surface