



فرست اوتوماشن

Emergency Light

Series CZ0879/1



Prodcuts Features

- It is convenient to be mounted and maintained.
- It can be fitted with lamp shade.
- The degree of protection is up to IP66.
- IECEx, ATEX International certification

Product Parameter

Product type:	Explosion-proof light fittings
Certification:	CCC IECEX ATEX
Application range (zones):	3G/Gc/2 zone; 2D/Db/21 zone
Min.ambient temperature:	-40°C
Max.ambient temperature:	+55°C
Degree of protection:	IP66
Rated voltage:	220V AC 50Hz 220V AC、230V AC、240V AC 50Hz、 60Hz 120V/208V/240V/277V/480V AC 60Hz



فرست اوتوماشن

Emergency Light

Series CZ0879/1



Contact

info@first-automation.com.eg/ • 01101619222 – 01100200886 • <https://first-automation.com.eg/>



فرست اوتوماشن

Emergency Light

Series CZ0879/1



The cage type terminals are more convenient for wiring.



Ferrule suspension hook chain design between the kits of glass cover and the body is applied. It is more convenient to be mounted and maintained.



The stainless steel mesh can be equipped as per request.



The mounting ways of the explosion-proof platform light fittings C-90°



Bracket installation, multiple angle adjustment



Chain type
(The light fitting can be equipped with the lamp shade as request.)



The mounting ways of the explosion-proof platform light fittings D-25°



Wall type lamp



Pendant pole type lamp



فرست اوتوماشن

Emergency Light

Series CZ0879/1

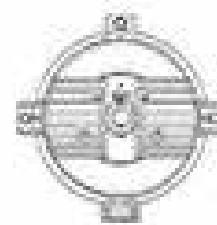
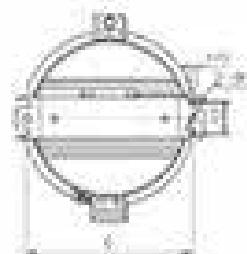
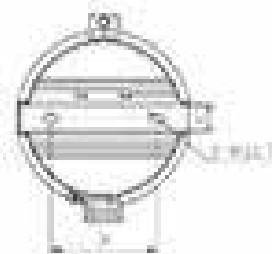
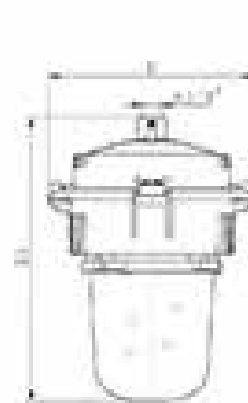
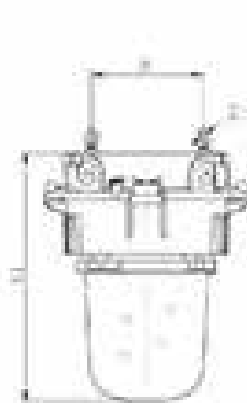
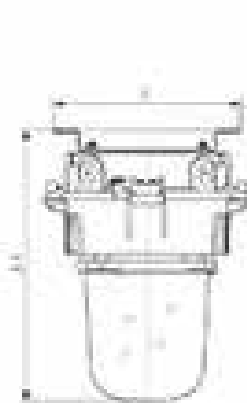
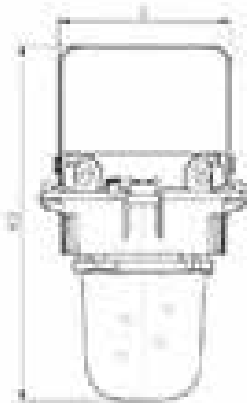
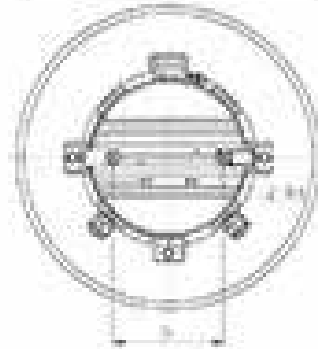
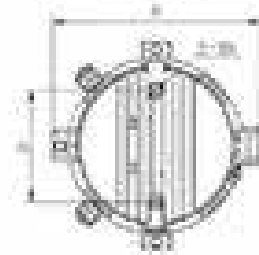
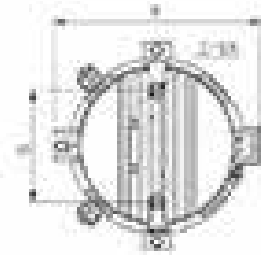
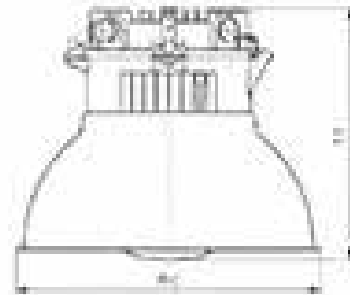
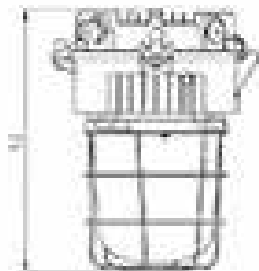
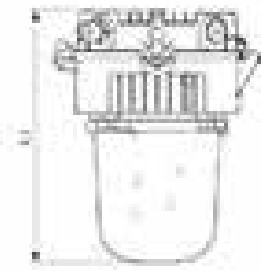

Unit:mm

Type	A1	A2	B	φC	D	A3	A4	A5	E	F	G
CZ0879-1	362	180	297	475	160	578	392	412	258	270	240
CZ0879-2	442	460	297	475	160	658	472	492	258	270	240
CZ0879-3	510	535	340	683	200	750	540	560	303	320	340



فرست اوتوماشن

Emergency Light

Series CZ0879/1

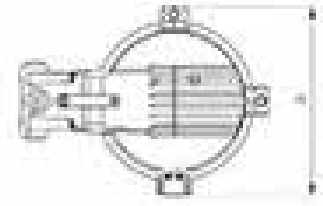
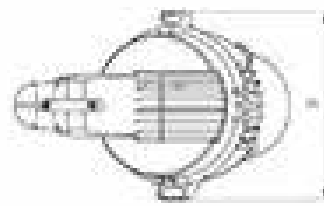
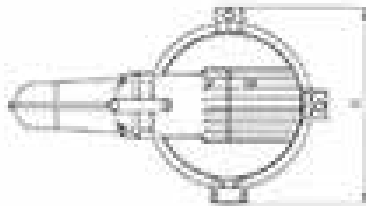
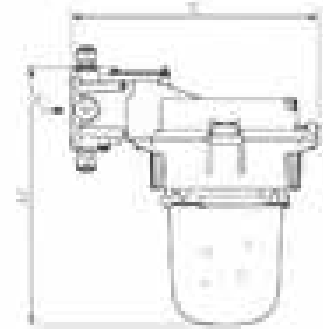
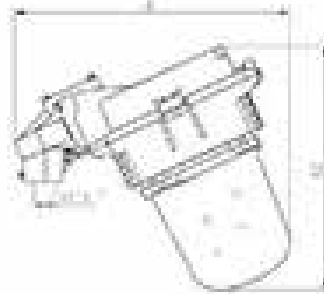
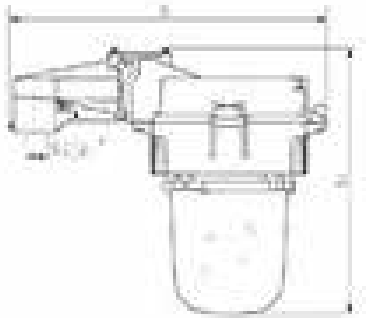

Unit:mm

Type	A1	A2	A3	B	C	D	E	E1	E2
CZ0879/1	405	366	406	480	435	297	391	2493	2573
CZ0879/2	485	460	486	480	465	297	391	2490	2575
CZ0879/3	535	510	533	535	530	350	443	2490	2600

A represents a bulbless ones (Mol plastic) M27 cable gland.

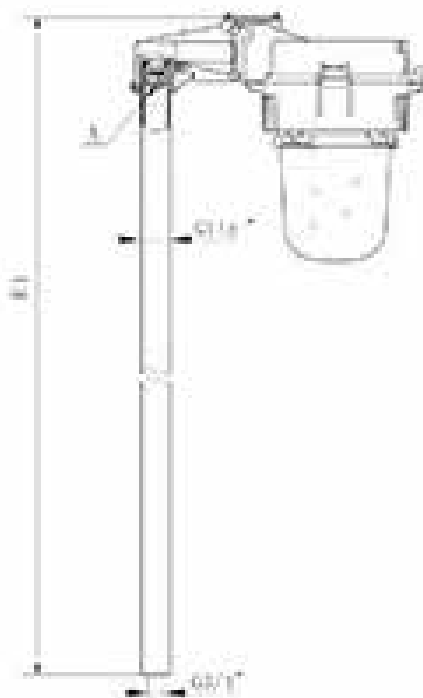

C — Lamp cap mounted in the angle of 99° (Inco type)

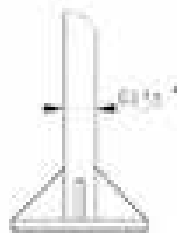

Flange type

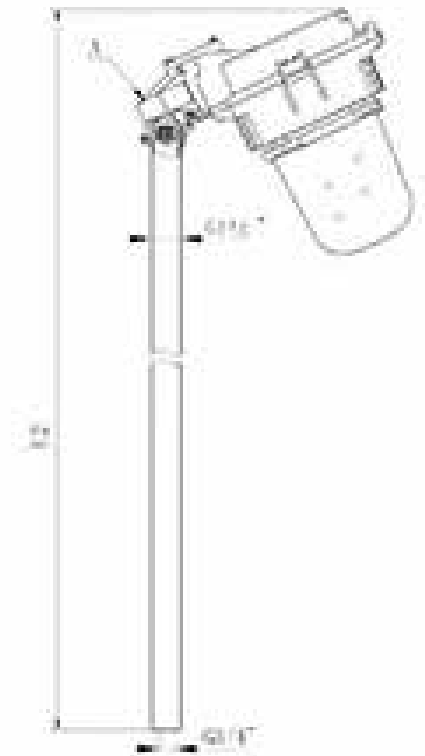

D — Lamp cap mounted in the angle of 23° (Inco type)



فرست اوتوماشن

Emergency Light

Series CZ0879/1



Illustration	Order No.	Illustration	Order No.
<p>CZ0879/1 (LED)</p>	CZ0879/1-LED30W17-□+□	<p>CZ0879/1</p>	CZ0879/1-QL50W57-□+□
	CZ0879/1-LED45W17-□+□		CZ0879/1-QL85W57-□+□
	CZ0879/1-LED60W17-□+□		CZ0879/1-JN45W57-□+□
	CZ0879/2-LED90W17-□+□		CZ0879/1-JN65W57-□+□
	CZ0879/2 (LED)		CZ0879/1-J70W25-□+□
<p>CZ0879/2</p>	CZ0879/2-J250W25-□+□	<p>CZ0879/3</p>	CZ0879/3-QL135W57-□+□
	CZ0879/2-N150W25-□+□		CZ0879/3-QL165W57-□+□
	CZ0879/2-N250W25-□+□		CZ0879/3-J250W25-□+□
			CZ0879/3-J400W25-□+□
			CZ0879/3-N250W25-□+□
			CZ0879/3-N400W25-□+□

Contact

info@first-automation.com.eg/ • 01101619222 – 01100200886 • https://first-automation.com.eg/



فرست اوتوماشن

Emergency Light

Series CZ0879/1



Optional Ex components



| CZ0220 Series Plastic stopping plugs, the reducer



| CZ0221 Metal cable glands



| CZ0220 Series Plastic cable glands, stopping plugs



| CZ0226 Increased safety cable glands



| CZ0527, CZ1725/27 Increased safety breathing, drainage valve



| CZ0227 Increased safety metal cable glands



| CZ1725/1C Metal cable glands



| CZ1725/2A Metal cable glands



| CZ1725/3A Metal stopping plug



| CZ1725/1A Metal cable glands



| CZ1725/4A The reducer



| CZ1725/1B Metal cable glands



فرست اوتوماشن

Emergency Light

Series CZ0879/1



Accessories



D8722/2

Ceiling bracket



D623

Chain type accessories(500mm)
Accessories for bracket type lamp, M8 bolt, made
from steel
with zinc-coated surface



D8726

Accessories for platform type lamp, G1 1/2 "
galvanized steel
pipe material and powder coated surface



"OSRAM"
energy-saving
lamp bulb
(Helix type)





فرست اوتوماشن

Emergency Light

Series CZ0879/1

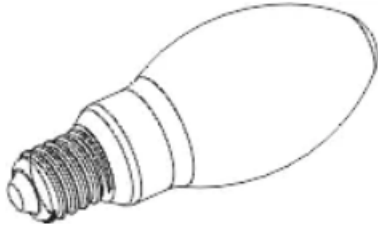

Accessories

 <p>D8719/1</p>	<p>Mounting bracket</p>
 <p>D732</p>	<p>G3/4"-300mm Straight pipe Accessories for bracket type, galvanized steel pipe material and powder coated surface</p>
 <p>D8725</p>	<p>Lamp pole of fence type Accessories for platform type lamp, G1 1/2 " galvanized steel pipe material and powder coated surface</p>
	<p>Metal halide lamp bulb-J</p>



فرست اوتوماشن

Emergency Light

Series CZ0879/1



Accessories

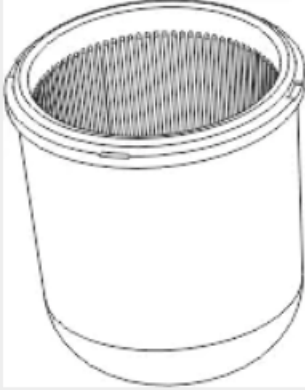

BL192/210

Parts of toughen glass cover
BL192/210:Used for CZ0879/1 light fittings

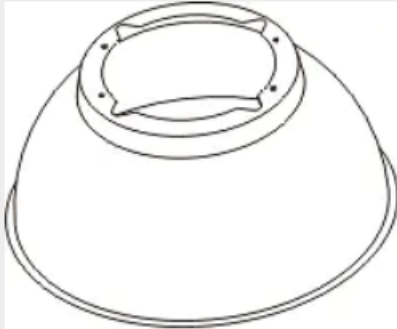

D8724/1

lamp shade



فرست اوتوماشن

Emergency Light

Series CZ0879/1



Accessories



D8718/1

Mesh

D8718/1: Used for CZ0879/1 light fittings, the material is stainless steel

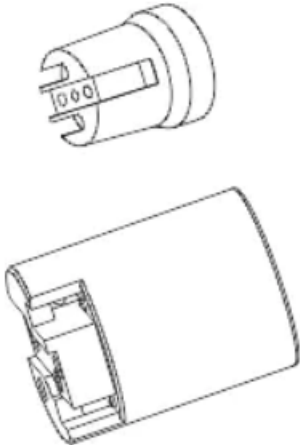

K547H, 132/E40

Ceramics lampholder



فرست اوتوماشن

Emergency Light

Series CZ0879/1



Accessories

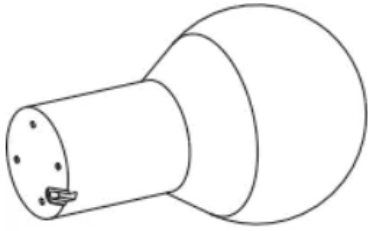

Electromagnetic
induction
energy-saving
lamp bulb

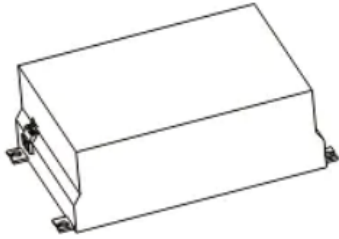

frequency
generator

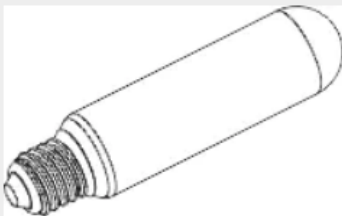

High pressure sodium
vapor lamp bulb-N